











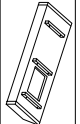
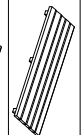
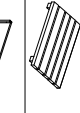
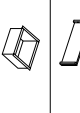
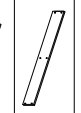
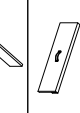

Assembly Instructions for OS0097D

Part List

Part No.	Part Image	Part Name	QTY
A		Wooden Right Feet	1
B		Wooden Middle Feet	1
C		Wooden Left Feet	1
D		Wooden Crosspiece	1
E		Wooden Shelf	1
F		Wooden Middle Shelf	1
L		Wooden Panel	1
H		Zinc Basin	1
J		Wooden Back Panel	1
G		Drawer Front Panel	1
K		Drawer Left Panel	1
M		Drawer Right Panel	1
N		Drawer-Bottom Board	1
P		Drawer Back Panel	1
a		6x50mm Screw	6
b		4.2x30mm Screw	18
d		6x55mm Screw	6
c		Wooden Tenon	4

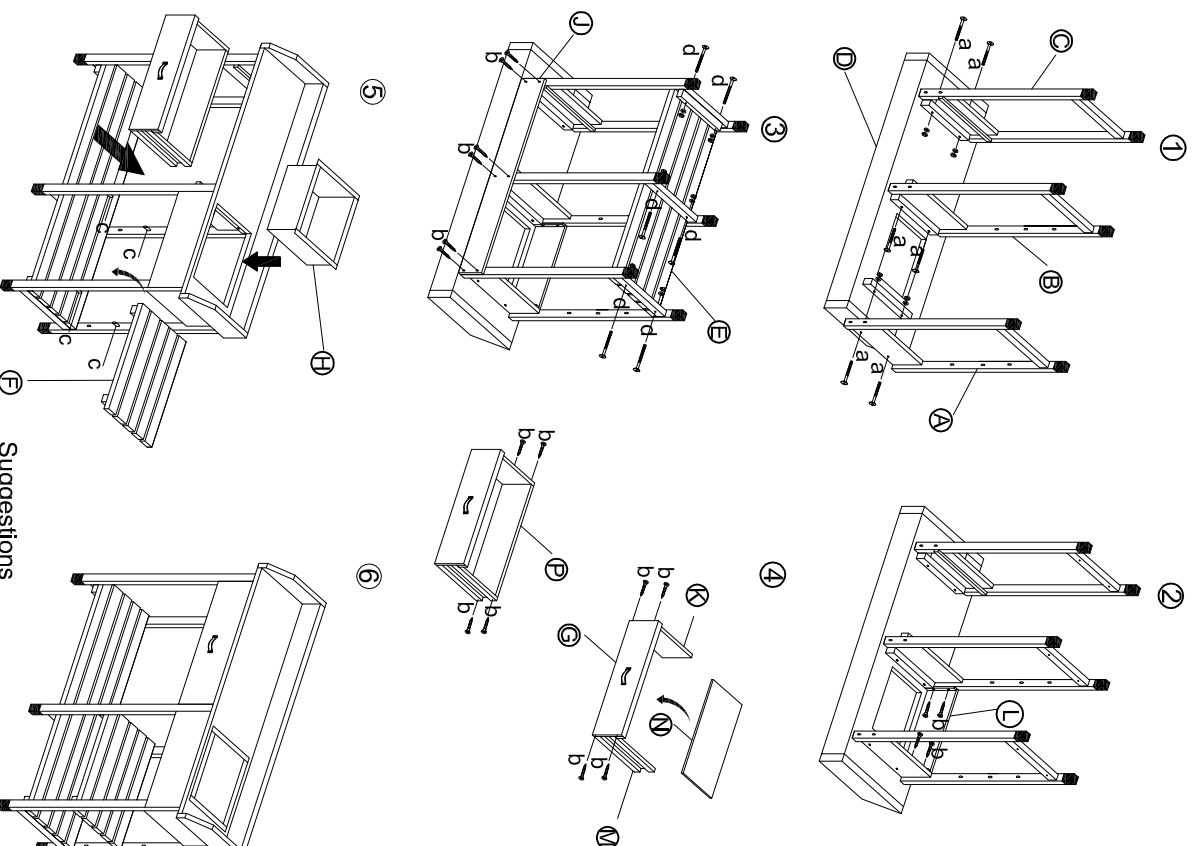

Suggestions

1. Two person at least.
2. Assembled on the flat, soft ground.
3. Screw driver.

NOTES: Do not tighten bolts fully until parts all are connected