













# Assembly Instructions for LS6536D

## Part List

Part No.	Part Image	Part Name	QTY
A		Wooden Left Panel	1
B		Wooden Right Panel	1
C		Wooden Back Panel	1
D		Wooden Crosspiece	1
E		Wooden Shelf	3
F		Wooden Support	1
G		Wooden Door	2
H		Wooden Lid	1
a		3.5x45mm Screw	8
b		3x16mm Screw	12
c		3.5x30mm Screw	1
d		6x60mm Screw	4

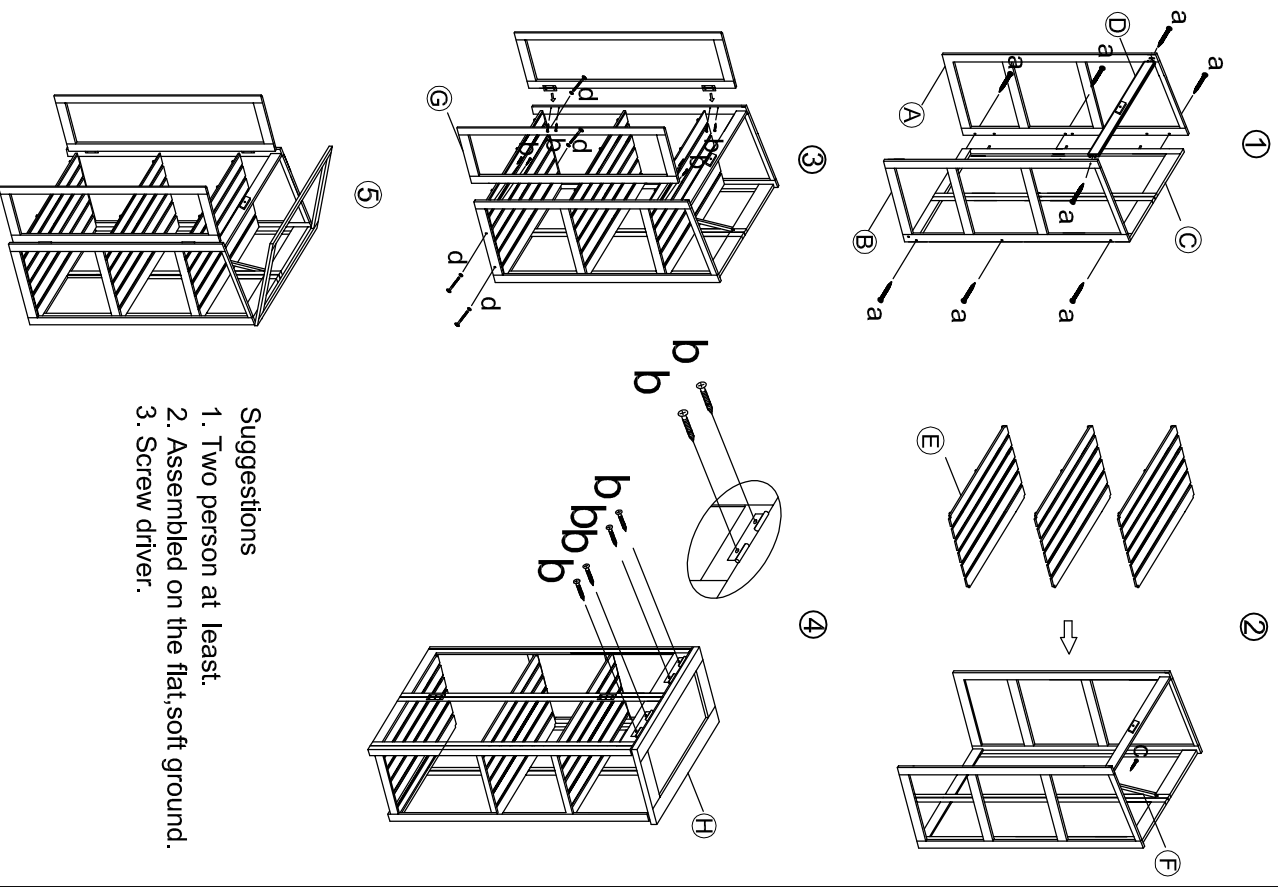

### Suggestions

1. Two person at least.
2. Assembled on the flat, soft ground.
3. Screw driver.

**NOTES: Do not tighten bolts fully until parts all are connected**